

Area of a triangle (3)

1 Calculate the area of the triangle.

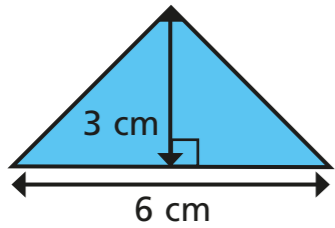

area = cm²

2 Calculate the area of the triangles.

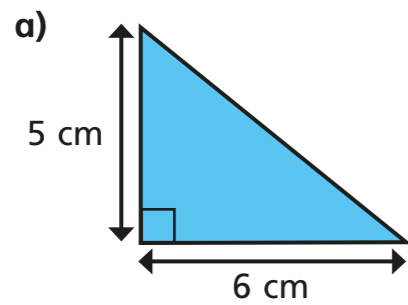

area = cm²

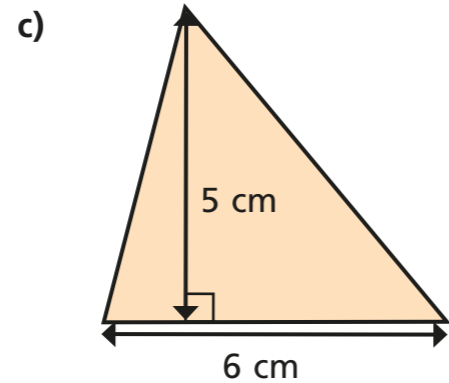

area = cm²

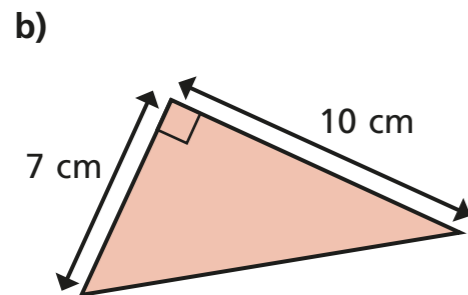

area = cm²

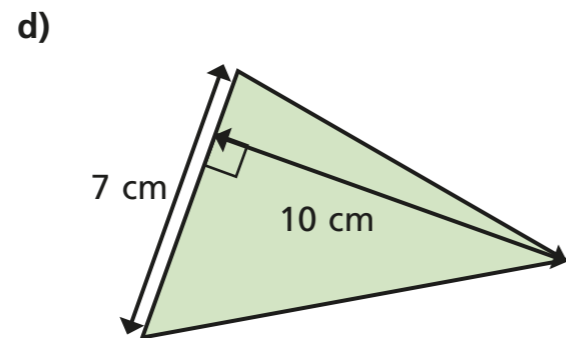

area = cm²

3 What mistake has Dora made?

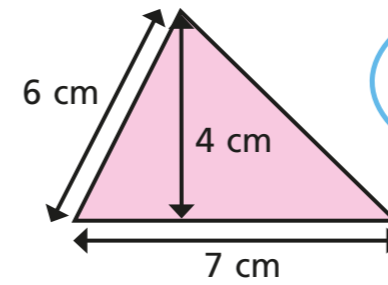

To find the area you do
 $7 \times 6 \div 2 = 21 \text{ cm}^2$

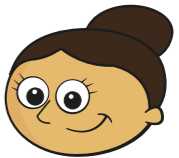

4 Label the base of each triangle *b*.
Label the perpendicular height *h*.

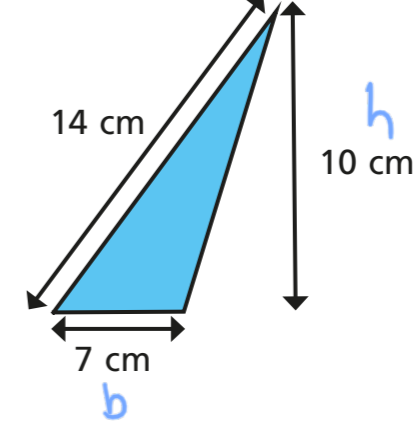
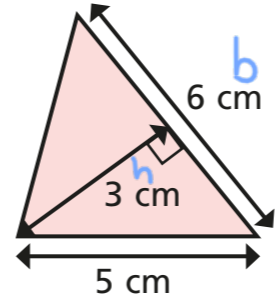
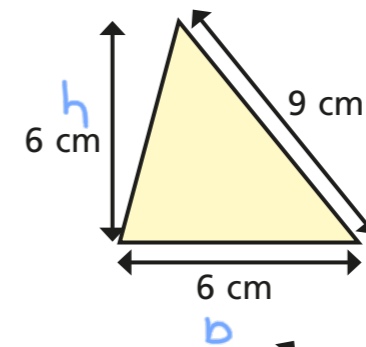
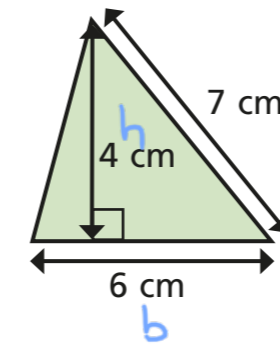

5 Are the statements always, sometimes or never true?

The side at the bottom of a triangle is the base.

Sometimes

The perpendicular height is equal to the vertical height.

Sometimes

6 Calculate the area of the triangles.

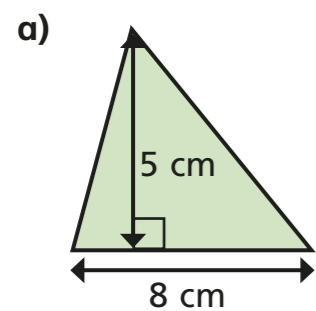

area = cm²

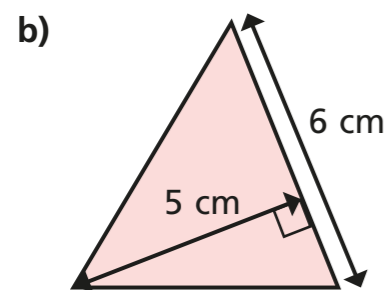

area = cm²

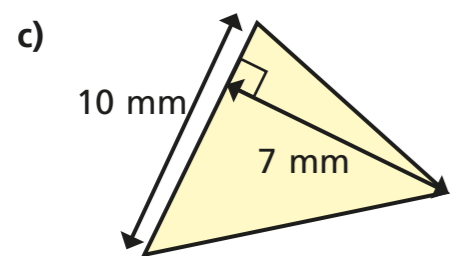

area = mm²

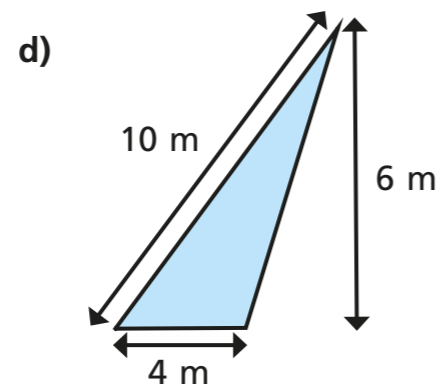

area = m²

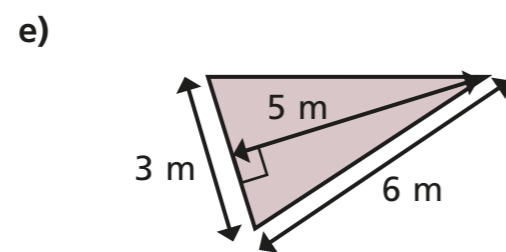

area = m²

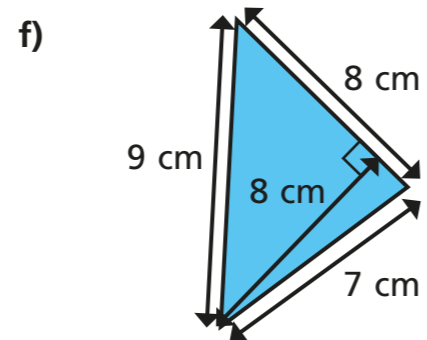

area = cm²

7 Find the area of the shaded region.

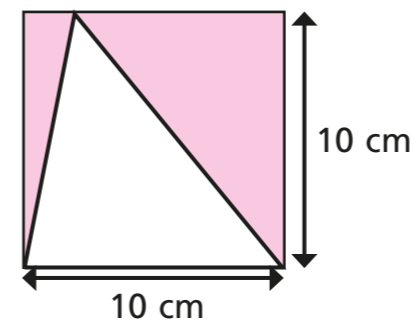

area = cm²

8 The area of each triangle is 12 cm². Find the missing lengths.

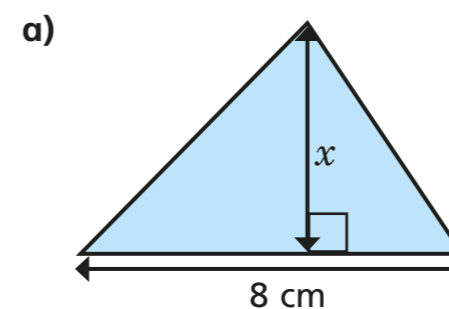

$x =$ cm

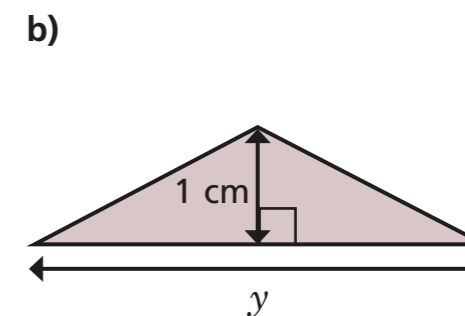

$y =$ cm

9 Show two ways you can work out the area of the triangle.

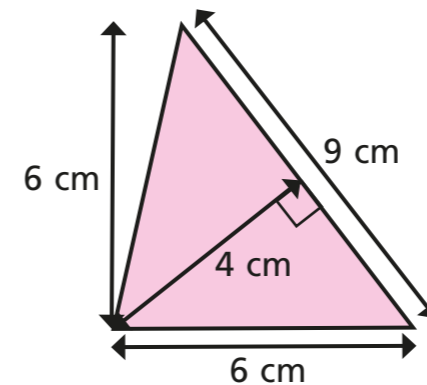

Compare answers with a partner.

